

# PCMflash module 42

Denso SH705x Bootloader

## Contents/Оглавление

Contents/Оглавление.....	2
DIESEL CARS: MAZDA, MITSUBISHI, NISSAN, SUBARU SH705x.....	3
OPEL 1.7L CDTI SH7058/SH7059 .....	4
OPEL 1.7L HYBRID SH7055 .....	5
DIESEL TRUCKS SH7055/SH7058.....	6
DIESEL TRUCKS SH7058 .....	7
ISUZU NPR (NQR) 5.2L DIESEL SH7058/SH7059.....	8
MAZDA PETROL SH7055/SH7058 .....	9
SUBARU 22611-AG57X SH7055.....	10
SUBARU METAL CASE (Металлический корпус) SH7055/SH7058.....	11
SUBARU PLASTIC CASE (Пластиковый корпус) SH7058(S).....	12
SUBARU STELLA 2008 SH7058S .....	13
SUBARU TCU SH7055/SH7058 .....	14
SUZUKI JIMNY, LIANA SH7055 .....	15
SUZUKI SH7055/SH7058 .....	16
VOLVO 2.4L SH7058 .....	17
JAGUAR X 2001-2008, S/XJ/XK 2003-2006 SH7055 .....	18

# PCMflash

Engine Control Unit

## SH705x

### T1 SH7055, SH7058



### T2

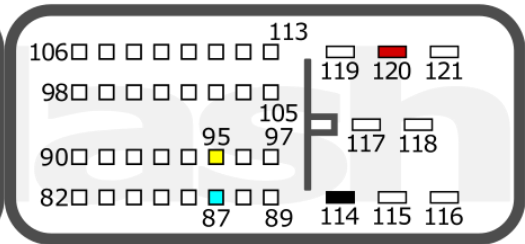

<b>+12V</b>	T2: 120	<b>CAN-L</b>	T2: 87
<b>GND</b>	T2: 114	<b>CAN-H</b>	T2: 95

### SH7058, SH7059

#### T96



#### T58

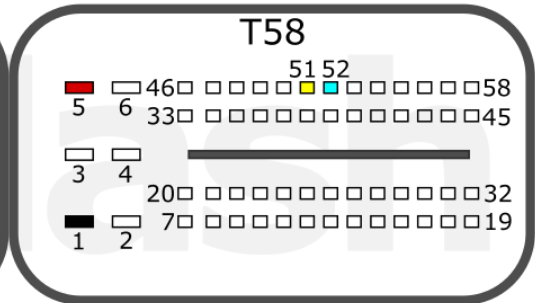

<b>+12V</b>	T58: 5	<b>CAN-L</b>	T58: 52
<b>GND</b>	T58: 1	<b>CAN-H</b>	T58: 51

### DIESEL CARS

MAZDA

MITSUBISHI

NISSAN

SUBARU

pcmflash.ru

v.1

2022-06-06

# PCMflash

Engine Control Unit

## SH7058/SH7059

T96



T58

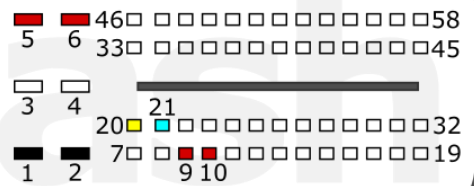

<b>+12V</b>	T58: 5, 6, 9, 10	<b>CAN-L</b>	T58: 21
<b>GND</b>	T58: 1, 2	<b>CAN-H</b>	T58: 20

OPEL 1.7L CDTI

pcmflash.ru

v.1

2022-06-06

# PCMflash

Engine Control Unit

## SH7055

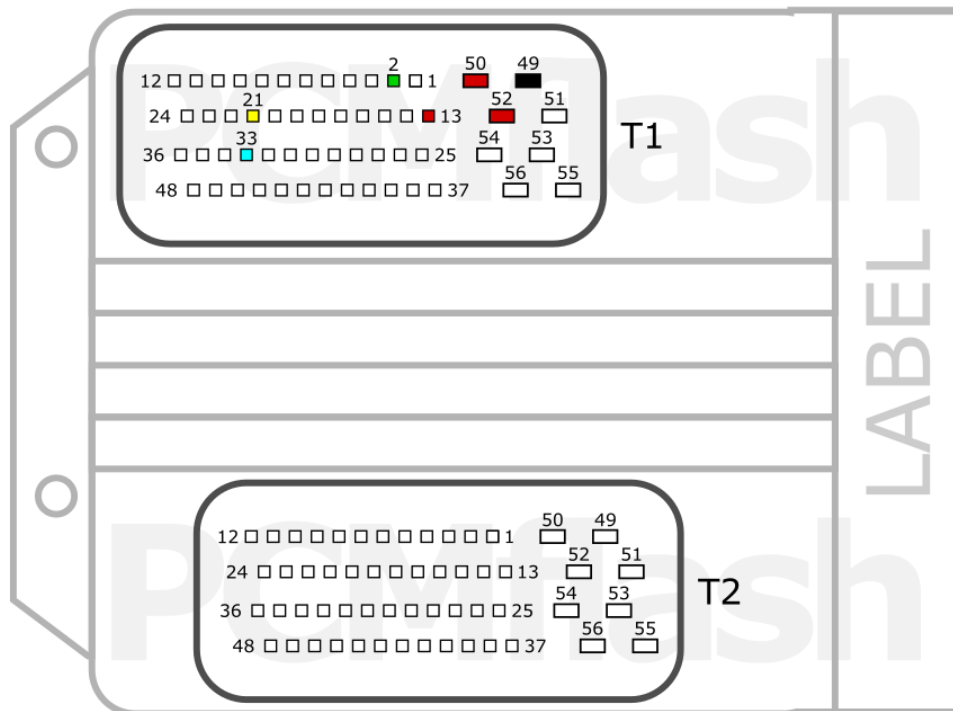

<b>+12V</b>	T1: 13, 50, 52	<b>CAN-L</b>	T1: 33
<b>GND</b>	T1: 49	<b>CAN-H</b>	T1: 21
<b>K-LINE</b>	T1: 2 (Not used)		

OPEL 1.7L HYBRID

pcmflash.ru

v.1

2022-06-06

# PCMflash

Engine Control Unit

## SH7055/SH7058

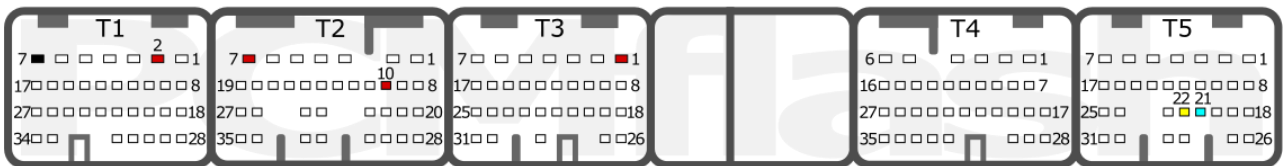

<b>+12V</b>	T1: 2; T2: 7, 10; T3: 1	<b>CAN-L</b>	T5: 21
<b>GND</b>	T1: 7	<b>CAN-H</b>	T5: 22

DIESEL TRUCKS

pcmflash.ru

v.1

2022-06-06

# PCMflash

Engine Control Unit

## SH7058

LABEL

T1

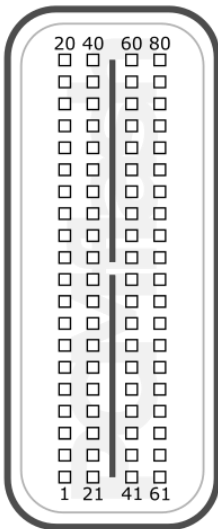

T2

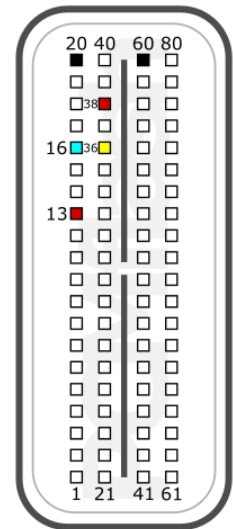

<b>+12V</b>	T2: 13, 38	<b>CAN-L</b>	T2: 16
<b>GND</b>	T2: 20, 60	<b>CAN-H</b>	T2: 36

DIESEL TRUCKS

pcmflash.ru

v.1

2022-06-06

# PCMflash

Engine Control Unit

## SH7058/SH7059

A

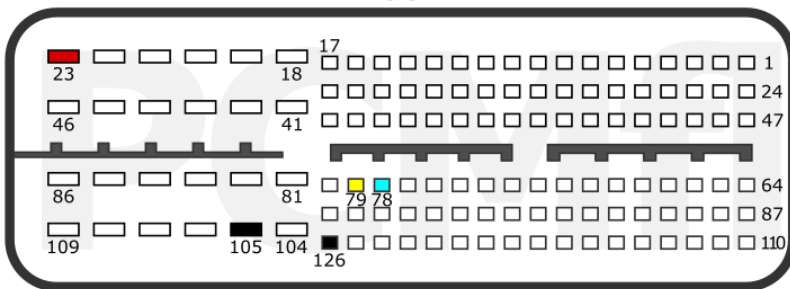

B

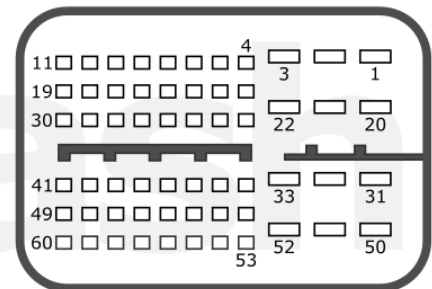

<b>+12V</b>	A: 23	<b>CAN-L</b>	A: 78
<b>GND</b>	A: 105, 126	<b>CAN-H</b>	A: 79

ISUZU NPR (NQR) 5.2L DIESEL

pcmflash.ru

v.1

2022-06-07



# PCMflash

Engine Control Unit

## SH7055/SH7058

### MAZDA 2 (DE) ZY

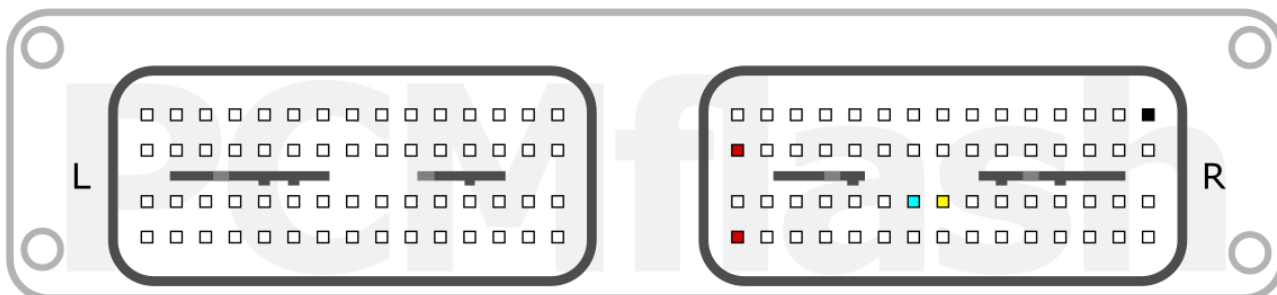

<b>+12V</b>	RED	<b>CAN-L</b>	CYAN
<b>GND</b>	BLACK	<b>CAN-H</b>	YELLOW

### MAZDA 3 (BK) Z6

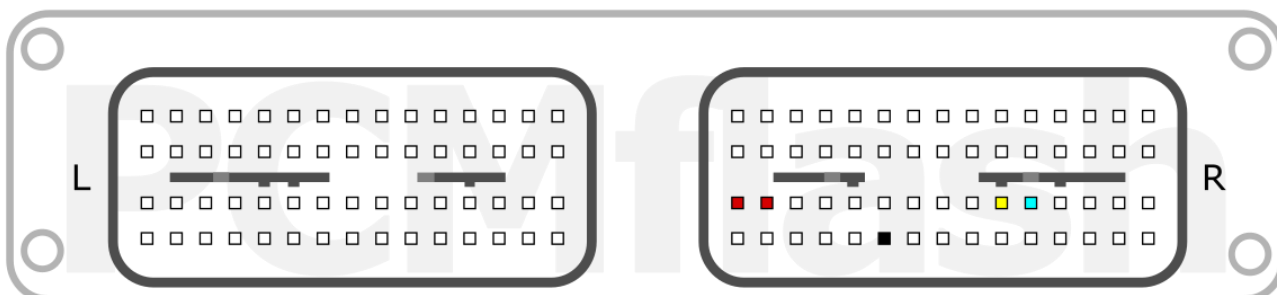

<b>+12V</b>	RED	<b>CAN-L</b>	CYAN
<b>GND</b>	BLACK	<b>CAN-H</b>	YELLOW

### MAZDA PETROL

# PCMflash

Engine Control Unit

SH7055

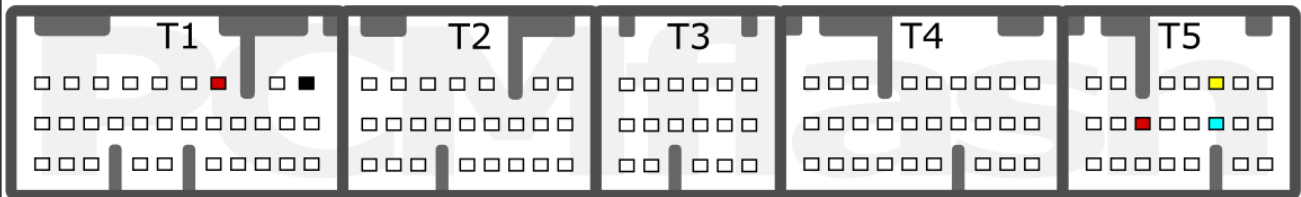

<b>+12V</b>	RED	<b>CAN-L</b>	CYAN
<b>GND</b>	BLACK	<b>CAN-H</b>	YELLOW

SUBARU 22611-AG57X

pcmflash.ru

v.1

2022-01-27

# PCMflash

Engine Control Unit

## SH7055/SH7058

EJ (2.0T, 2.5L, 2.5T, 3.0L, 3.6L) immo\*

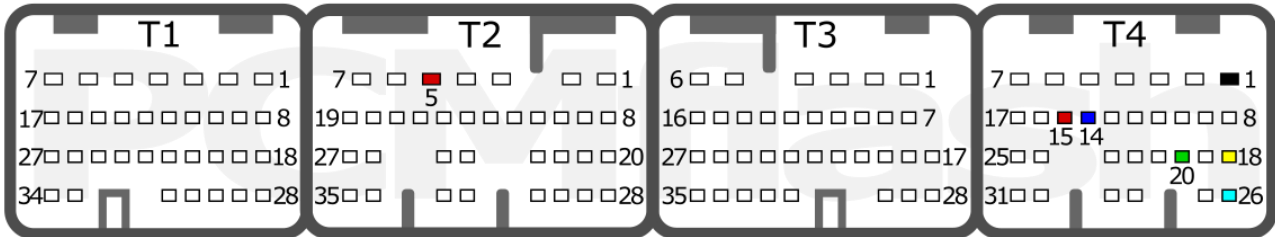

<b>+12V</b>	T2: 5; T4: 15	<b>CAN-L</b>	T4: 26
<b>GND</b>	T4: 1	<b>CAN-H</b>	T4: 18
<b>K-LINE</b>	T4: 20 (Not used)	<b>TEST</b>	T4: 14 (Not used)
* Машины с иммобилайзером / cars with immo			

EJ (2.0T, 2.5L, 2.5T, 3.0L, 3.6L) w/o immo\*

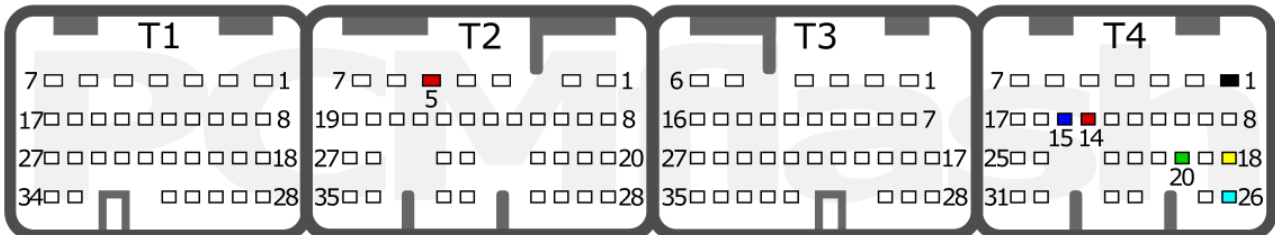

<b>+12V</b>	T2: 5; T4: 14	<b>CAN-L</b>	T4: 26
<b>GND</b>	T4: 1	<b>CAN-H</b>	T4: 18
<b>K-LINE</b>	T4: 20 (Not used)	<b>TEST</b>	T4: 15 (Not used)
* Машины без иммобилайзера / cars without immo			

SUBARU METAL CASE (Металлический корпус)

pcmflash.ru

v.1

2022-06-06

# PCMflash

Engine Control Unit

## SH7058(S)

EJ (2.0T, 2.5L, 2.5T, 3.0L, 3.6L) immo

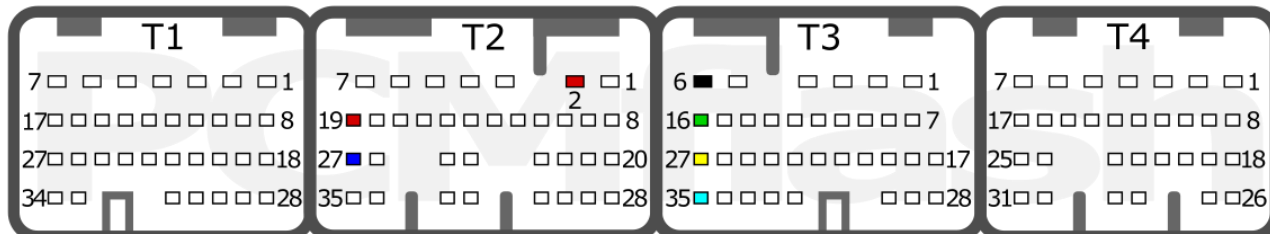

<b>+12V</b>	T2: 2, 19	<b>CAN-L</b>	T3: 35
<b>GND</b>	T3: 6	<b>CAN-H</b>	T3: 27
<b>K-LINE</b>	T3: 16 (Not used)	<b>TEST</b>	T2: 27 (Not used)

\* Машины с иммобилайзером / cars with immo

EJ (2.0T, 2.5L, 2.5T, 3.0L, 3.6L) w/o immo

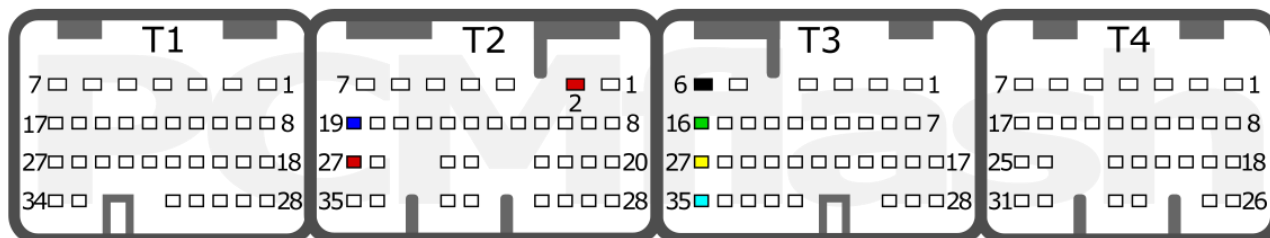

<b>+12V</b>	T2: 2, 27	<b>CAN-L</b>	T3: 35
<b>GND</b>	T3: 6	<b>CAN-H</b>	T3: 27
<b>K-LINE</b>	T3: 16 (Not used)	<b>TEST</b>	T2: 19 (Not used)

\* Машины без иммобилайзера / cars without immo

FB (1.6L, 2.0L, 2.5L)

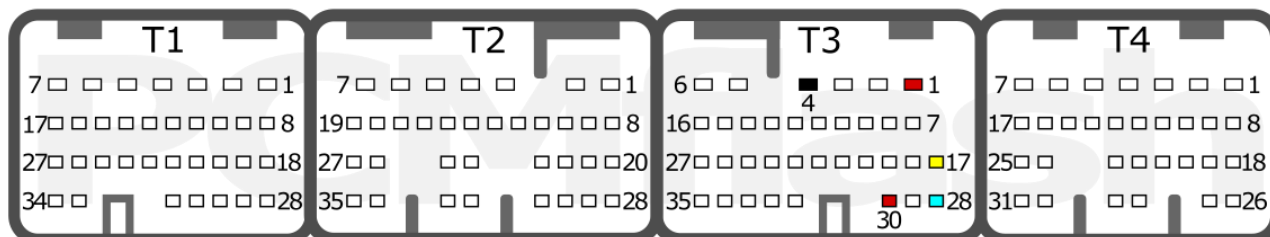

<b>+12V</b>	T3: 1, 30	<b>CAN-L</b>	T3: 28
<b>GND</b>	T3: 4	<b>CAN-H</b>	T3: 17

SUBARU PLASTIC CASE (Пластиковый корпус)

pcmflash.ru

v.1

2022-06-06

# PCMflash

Engine Control Unit

## SH7058S

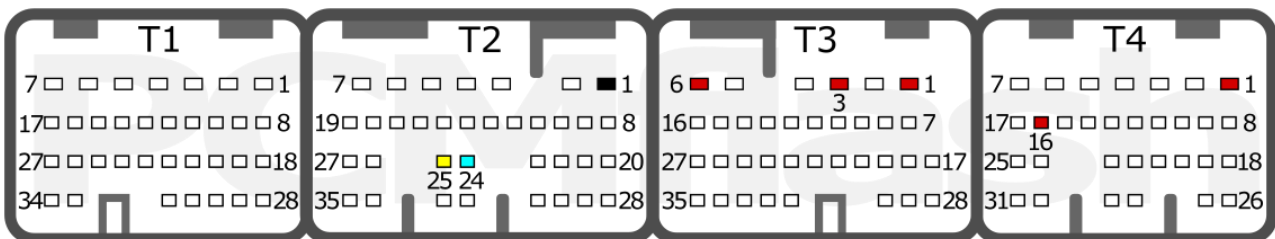

<b>+12V</b>	T3: 1, 3, 6; T4: 1, 16	<b>CAN-L</b>	T2: 24
<b>GND</b>	T2: 1	<b>CAN-H</b>	T2: 25

SUBARU STELLA 2008

pcmflash.ru

v.1

2022-02-11

# PCMflash

Transmission Control Unit

## SH7055/SH7058

### SH7055

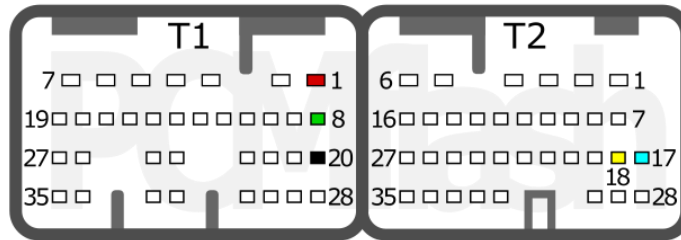

<b>+12V</b>	T1: 1	<b>CAN-L</b>	T2: 17
<b>GND</b>	T1: 20	<b>CAN-H</b>	T2: 18
<b>K-LINE</b>	T1: 8 (Not used)		

### SH7058

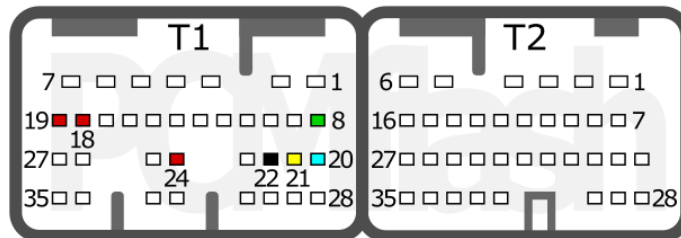

<b>+12V</b>	T1: 18, 19, 24	<b>CAN-L</b>	T1: 20
<b>GND</b>	T1: 22	<b>CAN-H</b>	T1: 21
<b>K-LINE</b>	T1: 8 (Not used)		

SUBARU TCU

pcmflash.ru

v.1

2022-06-07

# PCMflash

Engine Control Unit

## SH7055

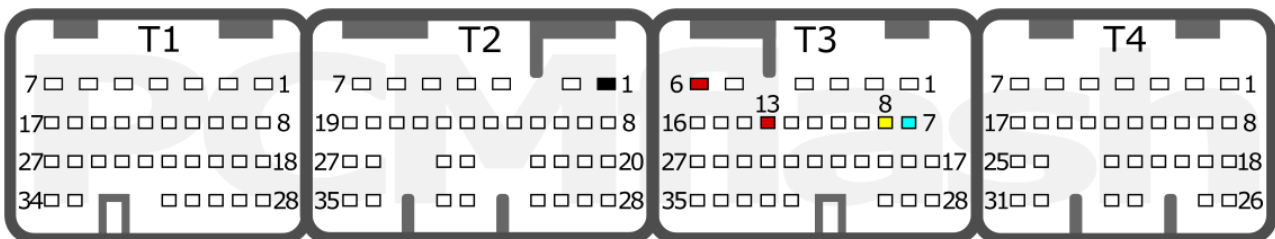

<b>+12V</b>	T3: 6, 13	<b>CAN-L</b>	T3: 7
<b>GND</b>	T2: 1	<b>CAN-H</b>	T3: 8

SUZUKI JIMNY, LIANA

pcmflash.ru

v.1

2022-01-25

# PCMflash

Engine Control Unit

## SH7055/SH7058

### 1.3, 1.5, 1.6L

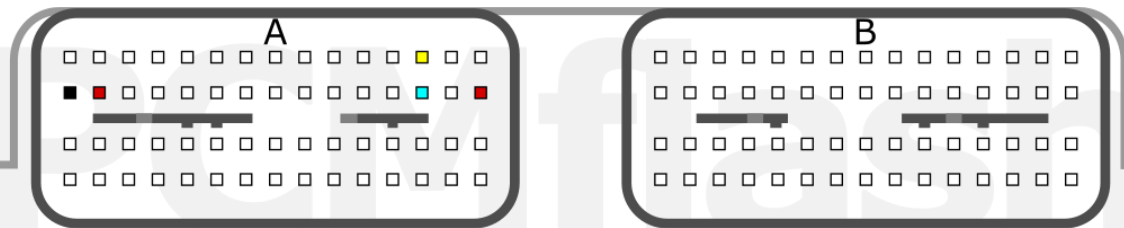

<b>+12V</b>	RED	<b>CAN-L</b>	CYAN
<b>GND</b>	BLACK	<b>CAN-H</b>	YELLOW

### 2.0, 2.4L

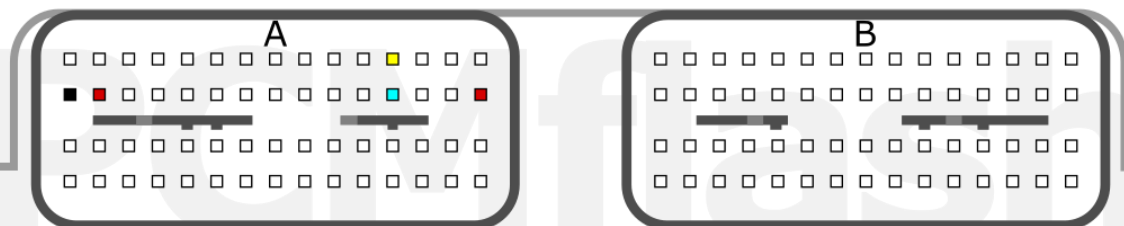

<b>+12V</b>	RED	<b>CAN-L</b>	CYAN
<b>GND</b>	BLACK	<b>CAN-H</b>	YELLOW

SUZUKI

pcmflash.ru

v.1

2022-06-08



# PCMflash

Engine Control Unit

## SH7058

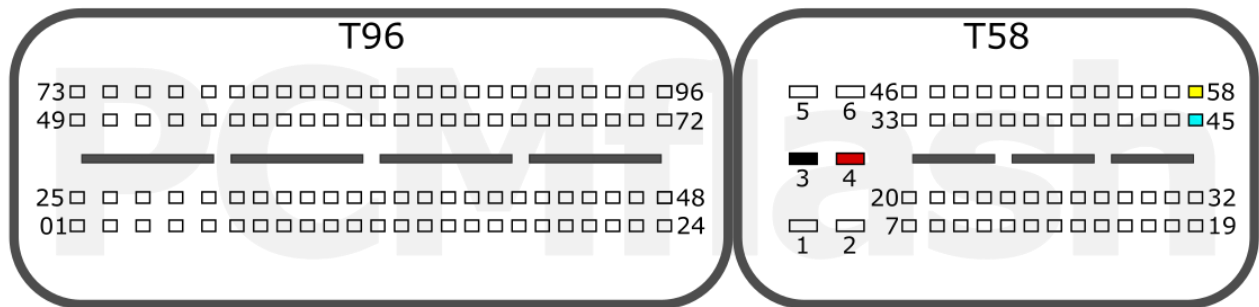

<b>+12V</b>	T58: 4	<b>CAN-L</b>	T58: 45
<b>GND</b>	T58: 3	<b>CAN-H</b>	T58: 58

VOLVO 2.4L

pcmflash.ru

v.1

2022-06-07

# PCMflash

Engine Control Unit

## SH7055

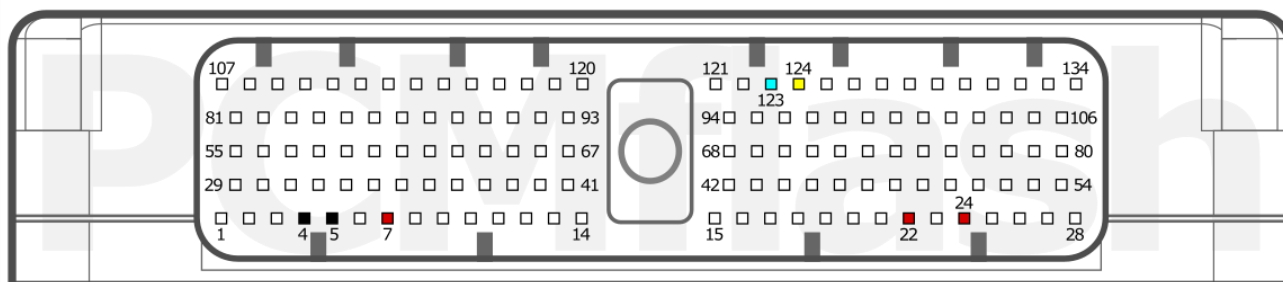

<b>+12V</b>	7, 22, 24	<b>CAN-L</b>	123
<b>GND</b>	4, 5	<b>CAN-H</b>	124

JAGUAR X 2001-2008, S/XJ/XK 2003-2006

pcmflash.ru

v.1

2022-06-06