

# PCMflash module 80

Denso SH725XX (GEN2)

## Contents/Оглавление

Contents/Оглавление.....	2
FAW SH72530 .....	3
HYUNDAI SH72546R .....	4
HINO/KIA/HYUNDAI TRUCK E6 SH72543R .....	5
MAZDA SH725xx .....	6
MAZDA TCM.....	7
MITSUBISHI 4N14 .....	8
NISSAN SH72531.....	9
SUBARU SH72531.....	10
SUZUKI SH72530(72533).....	11
VOLVO SH7254x .....	12

# PCMflash

Engine Control Unit

## SH72530

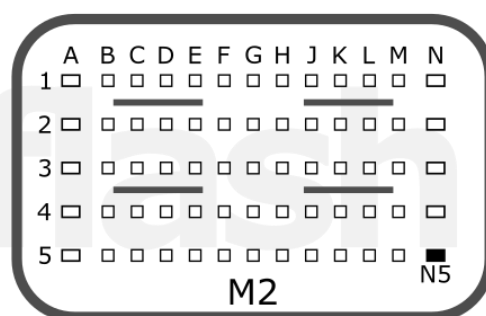
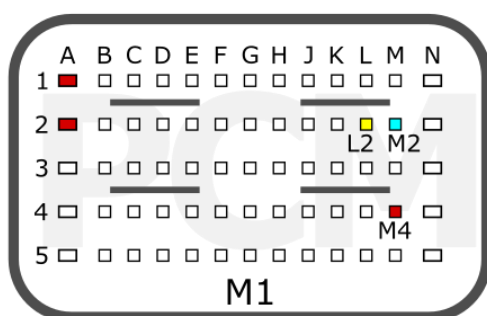

<b>+12V</b>	M1: A1, A2, M4	<b>CAN-L</b>	M1: M2
<b>GND</b>	M2: N5	<b>CAN-H</b>	M1: L2

FAW

pcmflash.ru

v.1

2021-09-13

# PCMflash

Engine Control Unit

KEFICO/DENSO SH72546R

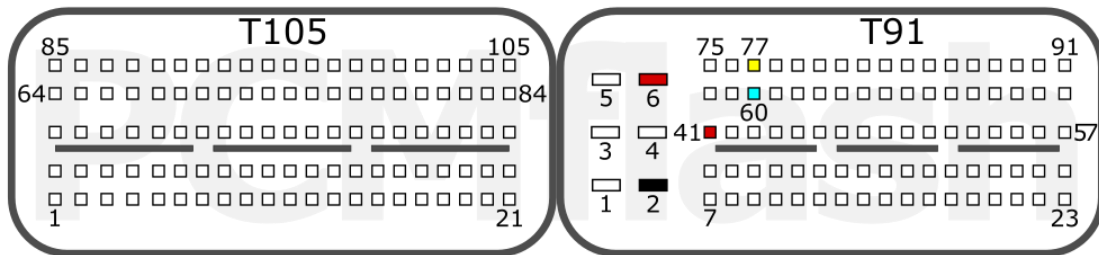

<b>+12V</b>	T91: 6, 41	<b>CAN-L</b>	T91: 60
<b>GND</b>	T91: 2	<b>CAN-H</b>	T91: 77

HYUNDAI

pcmflash.ru

v.1

2021-09-05

# PCMflash

Engine Control Unit

DENSO TRUCK E6 (SH72543R)

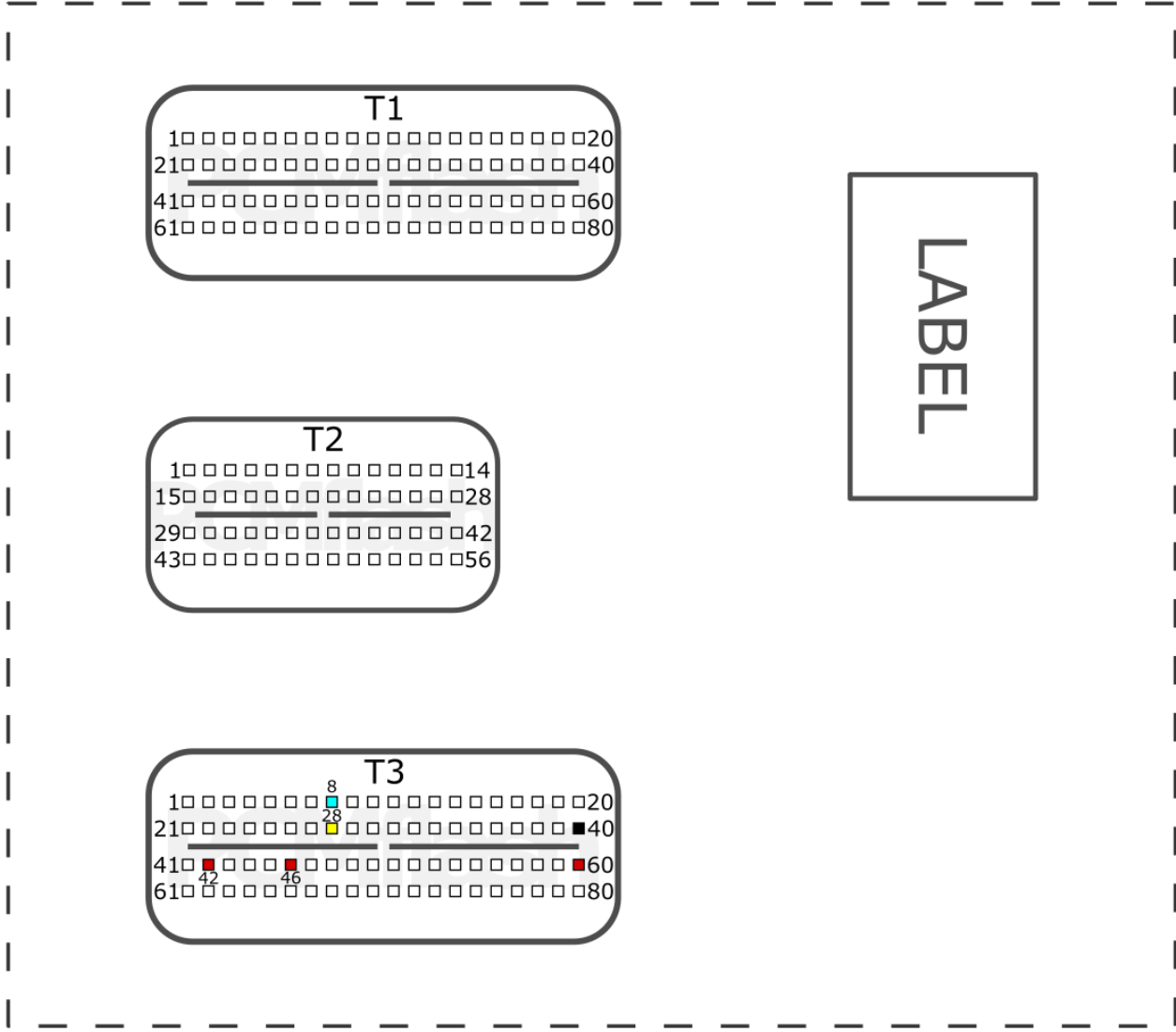

<b>+12V</b>	T3: 42, 46, 60	<b>CAN-L</b>	T3: 8
<b>GND</b>	T3: 40	<b>CAN-H</b>	T3: 28

HINO

KIA

HYUNDAI

pcmflash.ru

v.2

2021-12-09

# PCMflash

Engine Control Unit

## SH725xx

### SKYACTIV-G

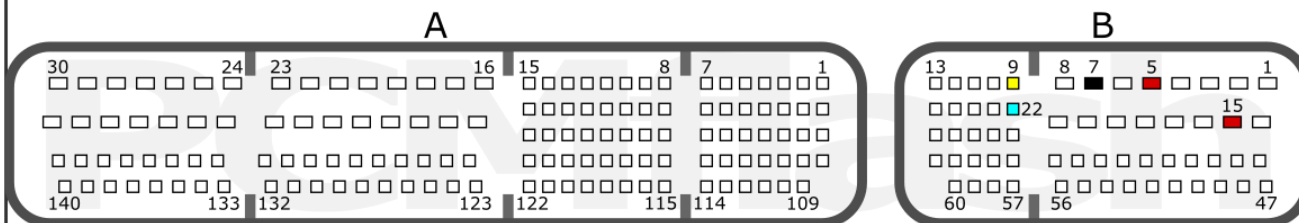

<b>+12V</b>	B: 5, 15	<b>CAN-L</b>	B: 22
<b>GND</b>	B: 7	<b>CAN-H</b>	B: 9

### SKYACTIV-D

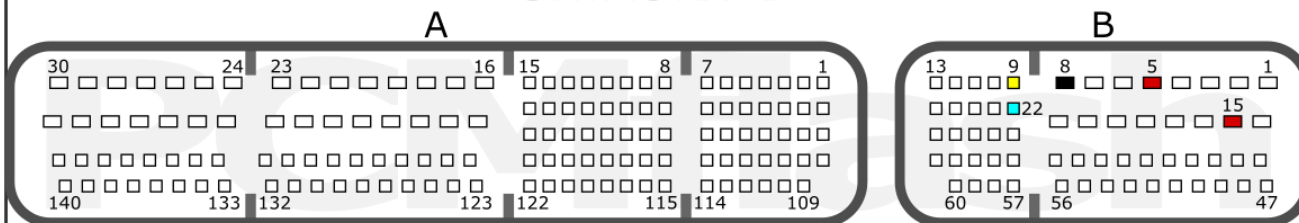

<b>+12V</b>	B: 5, 15	<b>CAN-L</b>	B: 22
<b>GND</b>	B: 8	<b>CAN-H</b>	B: 9

### SH72531

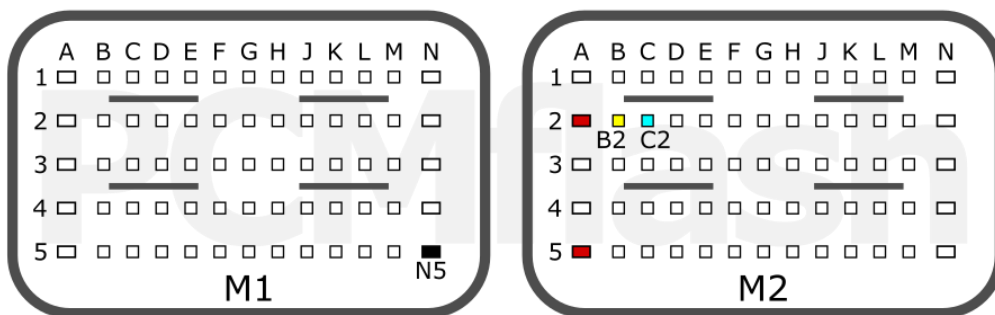

<b>+12V</b>	M2: A2, A5	<b>CAN-L</b>	M2: C2
<b>GND</b>	M1: N5	<b>CAN-H</b>	M2: B2

MAZDA

# PCMflash

Electronic Control Unit

## MAZDA TCM

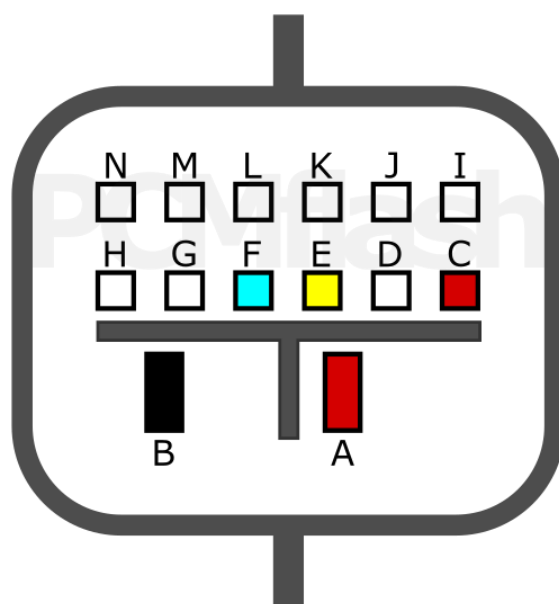

<b>+12V</b>	C, A	<b>CAN-L</b>	F
<b>GND</b>	B	<b>CAN-H</b>	E

MAZDA

# PCMflash

Engine Control Unit

## 4N14

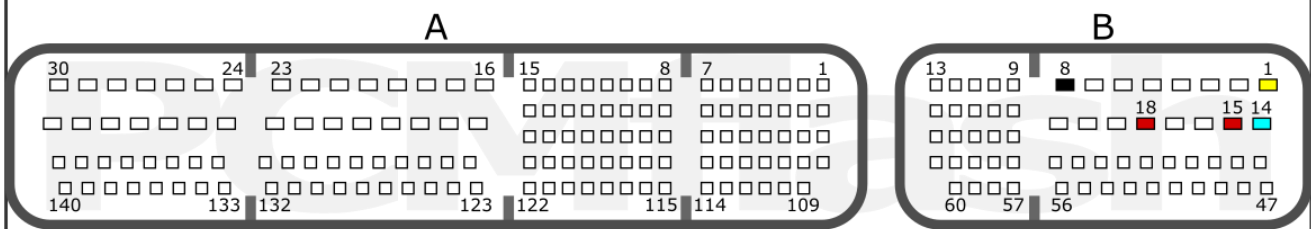

<b>+12V</b>	B: 15, 18	<b>CAN-L</b>	B: 14
<b>GND</b>	B: 8	<b>CAN-H</b>	B: 1

MITSUBISHI

pcmflash.ru

v.1

2021-09-05



# PCMflash

Engine Control Unit

## SH72531

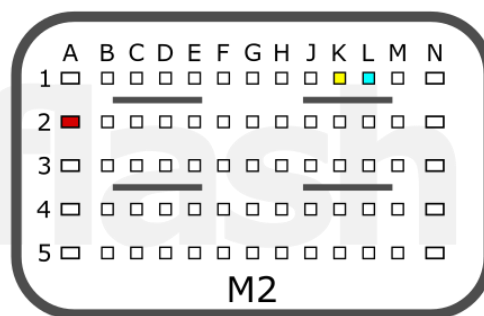
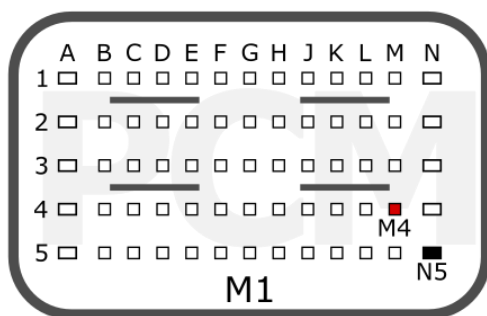

<b>+12V</b>	M1: M4, M2: A2	<b>CAN-L</b>	M2: L1
<b>GND</b>	M1: N5	<b>CAN-H</b>	M2: K1

NISSAN

pcmflash.ru

v.1

2021-09-13

# PCMflash

Engine Control Unit

## SH72531



<b>+12V</b>	T4: 1, 27	<b>CAN-L</b>	T4: 18
<b>GND</b>	T4: 4	<b>CAN-H</b>	T4: 19

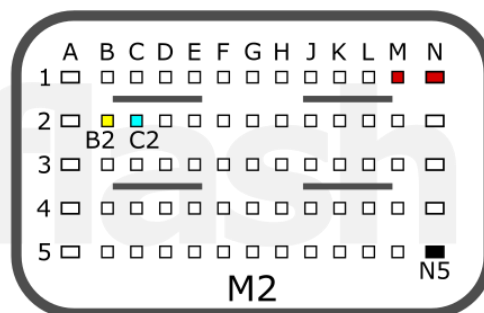
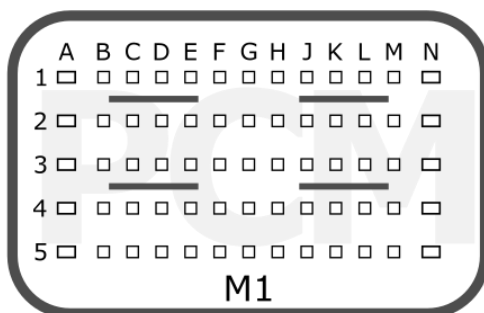

<b>+12V</b>	M2: M1, N1	<b>CAN-L</b>	M2: C2
<b>GND</b>	M2: N5	<b>CAN-H</b>	M2: B2

SUBARU

pcmflash.ru

v.1

2021-09-17

# PCMflash

Engine Control Unit

SH72530/SH72533

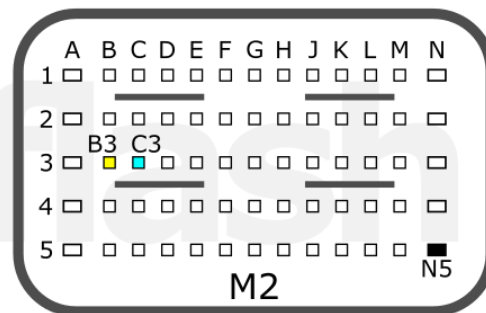
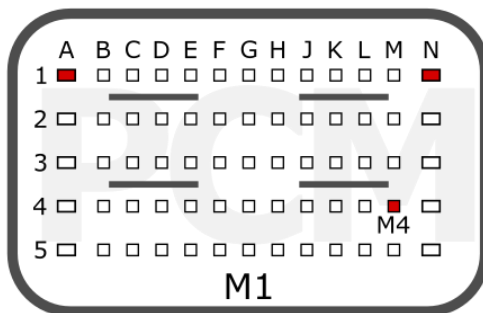

<b>+12V</b>	M1: A1, N1, M4	<b>CAN-L</b>	M2: C3
<b>GND</b>	M2: N5	<b>CAN-H</b>	M2: B3

SUZUKI

pcmflash.ru

v.1

2021-09-13

# PCMflash

Engine Control Unit

## SH7254x

### SH72543



<b>+12V</b>	T58: 5, 3, 15	<b>CAN-L</b>	T58: 41
<b>GND</b>	T58: 4	<b>CAN-H</b>	T58: 54

### SH72546

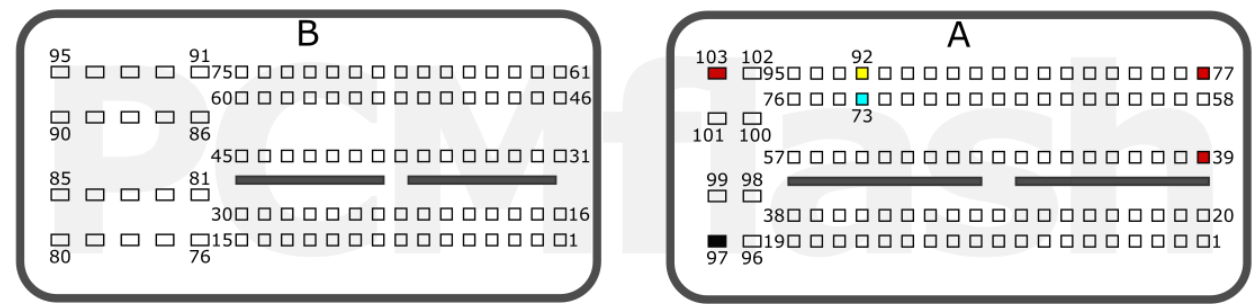

<b>+12V</b>	A: 103, 77, 39	<b>CAN-L</b>	A: 73
<b>GND</b>	A: 97	<b>CAN-H</b>	A: 92

VOLVO

pcmflash.ru

v.1

2021-08-16